

Article number: 03440030

Description: Fluro Rod end GE 30EC

Measures

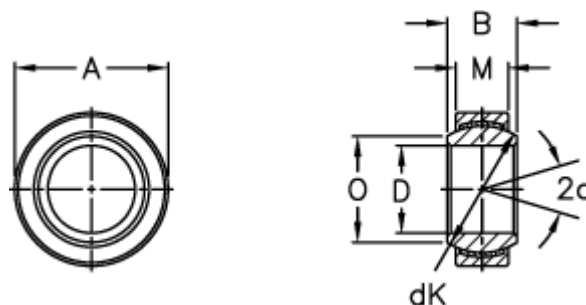

A	= 47 0 -0,011	Tilt angle = 6
B	= 22	Weight = 140
D	= 30 0 -0,010	
dK	= 40.7	
Dynamic load C (kN)	= 66	
M	= 18	
O	= 34.2	
Static load C0 (kN)	= 166	